

MATRIX X-GRIP MINI

Fast and easy clamping!

Unique form closure to hold, fix in position and clamp in precision mechanics, laboratory engineering, and measurement engineering.

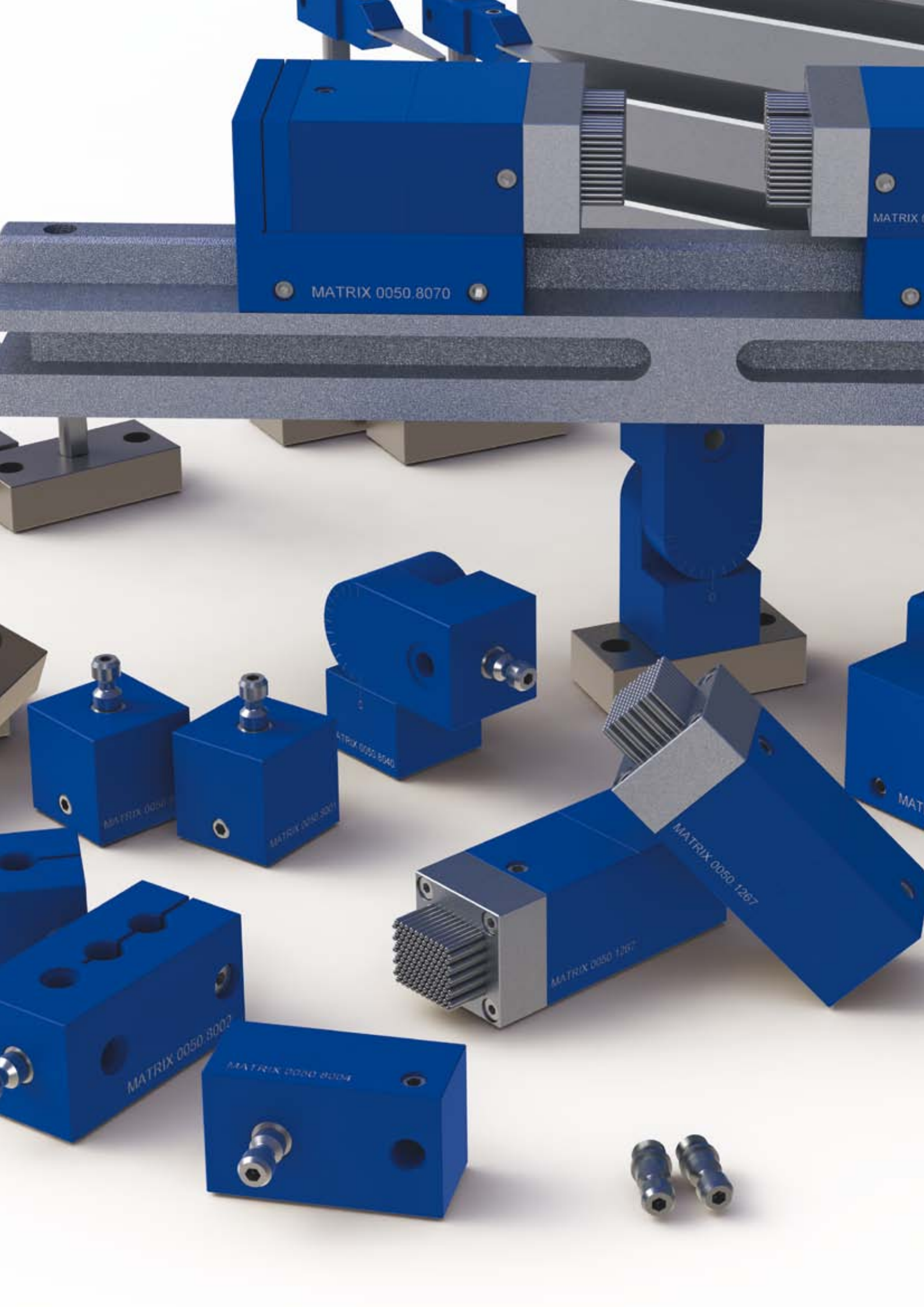



MATRIX 0050.8070

MATRIX

MATRIX 0050.8001

MATRIX 0050.8001

MATRIX 0050.8040

MATRIX 0050.1267

MATRIX 0050.1267

MATRIX 0050.8002

MATRIX 0050.8004



Global leader – MATRIX® clamping and mold clamping systems

The new clamping and mold clamping systems of MATRIX® in Ostfildern near Stuttgart will revolutionize your workflows in all areas of clamping technology and assembly and replace conventional clamping technology.

The new clamping systems are perfectly designed not only for laboratory engineering and measurement engineering, but also for all areas where perfect hold and adjustable mold clamping are required.

At your company you are responsible for the optimum design of workflows in measurement engineering and production technology. You know how difficult it can be to clamp workpieces

that have complicated geometries. The unique and revolutionary technology of our clamping and holding systems will help you optimize workflows.

The MATRIX® clamping systems with their individually movable pins replace cost-intensive special equipment and a wide range of shaping elements. The MATRIX® clamping modules quickly and individually provide a mirror image mold of the various workpiece contours.

- We are pleased to be able to showcase our new X-GRIP MINI mold clamping system for you.

• Content:	Page:
Fast, easy clamping – the X-GRIP MINI	4
X-GRIP MINI S	6
X-GRIP MINI M	8
X-GRIP MINI L	10
X-GRIP MINI XL	12
Overview	14



MATRIX® is the holder of the Baden-Württemberg Innovation Award – Dr.-Rudolf-Eberle-Preis –

Fast, easy clamping – the X-GRIP MINI

The latest development by MATRIX® is small and guarantees perfect mounting of even the most delicate workpieces.

Underlying the principle of the flexible MATRIX® pin system is the idea of shaping its support with the help of the workpiece. The original workpiece itself generates an absolutely true-to-shape contour with the help of the individually guided pins.

This mold is mechanically fixed. The part-specific and sturdy mold support is finished. Work that previously required lengthy milling or shaped supports, can now be completed in seconds. Whereas conventional supports could only be used for a single workpiece, the MATRIX®

pin system can adjust to any workpiece contour.

With the X-GRIP MINI you can now hold filigree workpieces quickly and precisely in the laboratory and in the precision measurement room.

And everything is mounted with one single tool.

Numerous individual modules and additional components are available for the modular design.

An adapter system, which is available as "optional equipment", allows you to use the X-GRIP MINI in combination with other MATRIX® products.

The advantages of X-GRIP MINI at a glance:

- Optimum clamping of even the smallest parts made possible by the minimal sized pins (1 mm pin diameter).
- Very fast, true-to-contour fixing of the workpiece.
- No stocking of specific workpiece supports.
- Up to 80% cost reduction in jig and fixture construction.
- Reusable, modular system.
- Easy handling and storing in the MATRIX® case.



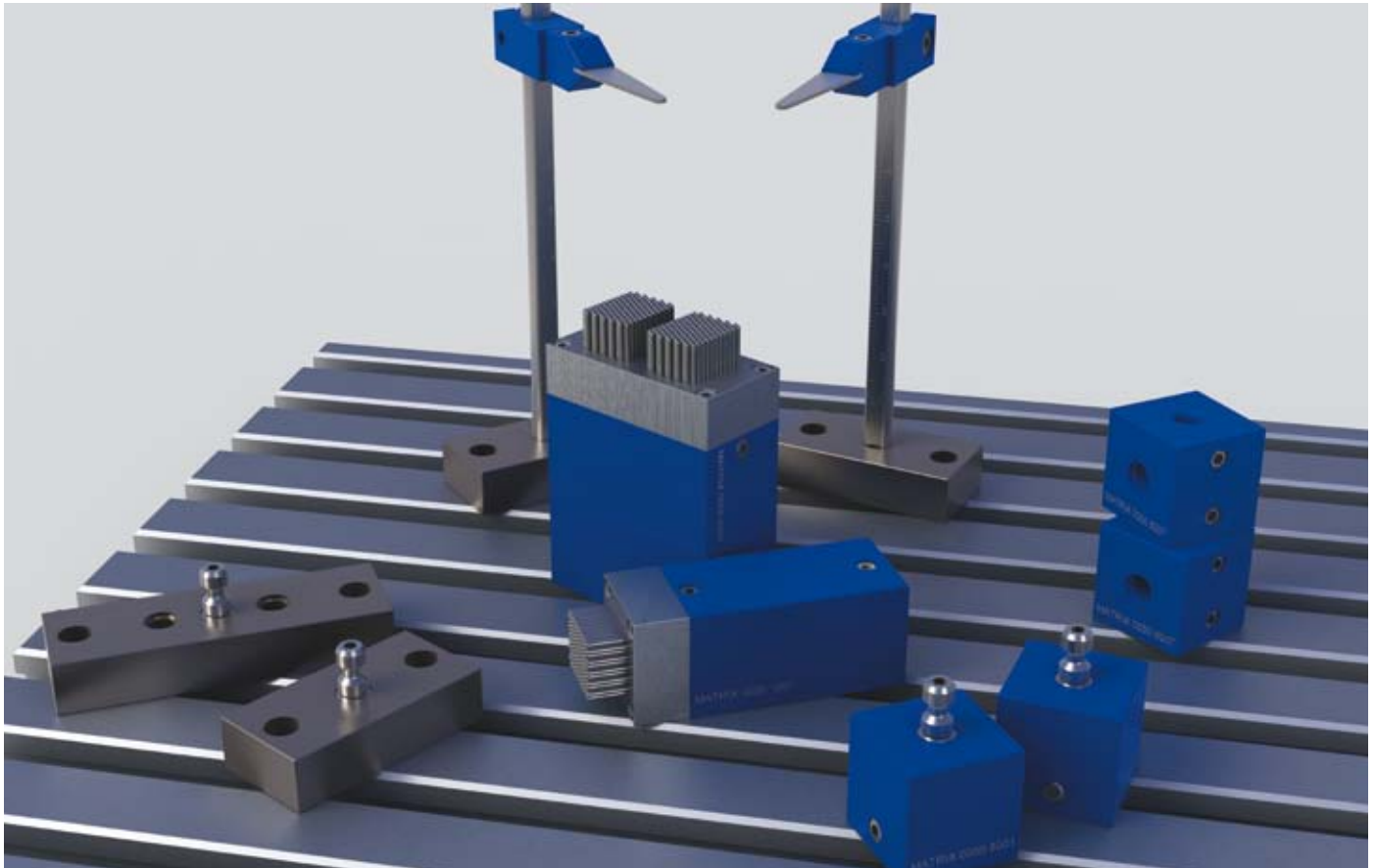



The **X-GRIP MINI S** generates the form-closure and lightning-fast **support** for filigree and lightweight parts in unsurpassed resolution (1 mm pin diameter).

The modular system consisting of the following individual components:

Modules	Article no.	Quantity	Designation	Dimensions and information		
	0050.1267	1 x	X-GRIP MINI Module, single	Outer dimensions: 20 x 20 x 50 mm, Tightening surface: approx. 14 x 11 mm, Number of pins: 126, Pin diameter: 1 mm, Stroke: 7.5 mm, Weight: approx. 67 g, Clamping screw: M4 hexagon SW2, Material pins/housing: stainless steel, aluminum: anodized, Adaption: connection pins: Ø 5, Installation location: any, Air connections for cleaning, Data sheet on request.		
	0050.2527	1 x	X-GRIP MINI Module, double	Outer dimensions: 20 x 40 x 50 mm, Tightening surface: approx. 14 x 11 mm, 2x, Number of pins: 252, Pin diameter: 1 mm, Stroke: 7,5 mm, Weight: approx. 132g, Clamping screw: M4 hexagon SW2, Material pins/housing: stainless steel, aluminum anodized, Adaption: connection pins: Ø 5, Installation location: any, Air connections for cleaning, Data sheet on request.		
Components	Article no.	Quantity	Designation/Info	Article no.	Quantity	Designation/Info
	0050.8009	3 x	Baseplate, single		0050.8008	1 x Baseplate, double
	0050.8052	2 x	Holding rod 100 mm with scale		0050.8003	2 x Holder, single

Components	Article no.	Quantity	Designation/Info	Article no.	Quantity	Designation/Info
	0050.8050	2 x	Pressure pad		0050.8007	2 x Double-joint 90°
	0050.8013	6 x	Connection pin with hexagon 13,5 mm		0900.2505	8 x Fastening kit for X-Grip
	0900.0200	1 x	T-slot baseplate 250 x 200 mm		0900.1000	1 x Micro screw- driver
	0900.9005	1 x	MATRIX® case			

Optional	Article no.	Quantity	Designation/Info	Article no.	Quantity	Designation/Info
	0050.8005	1 x	Adapter, single		0050.8006	1 x Adapter, double

An adapter system, which is available as “optional equipment”, allows you to use the X-GRIP MINI in combination with other MATRIX® products.



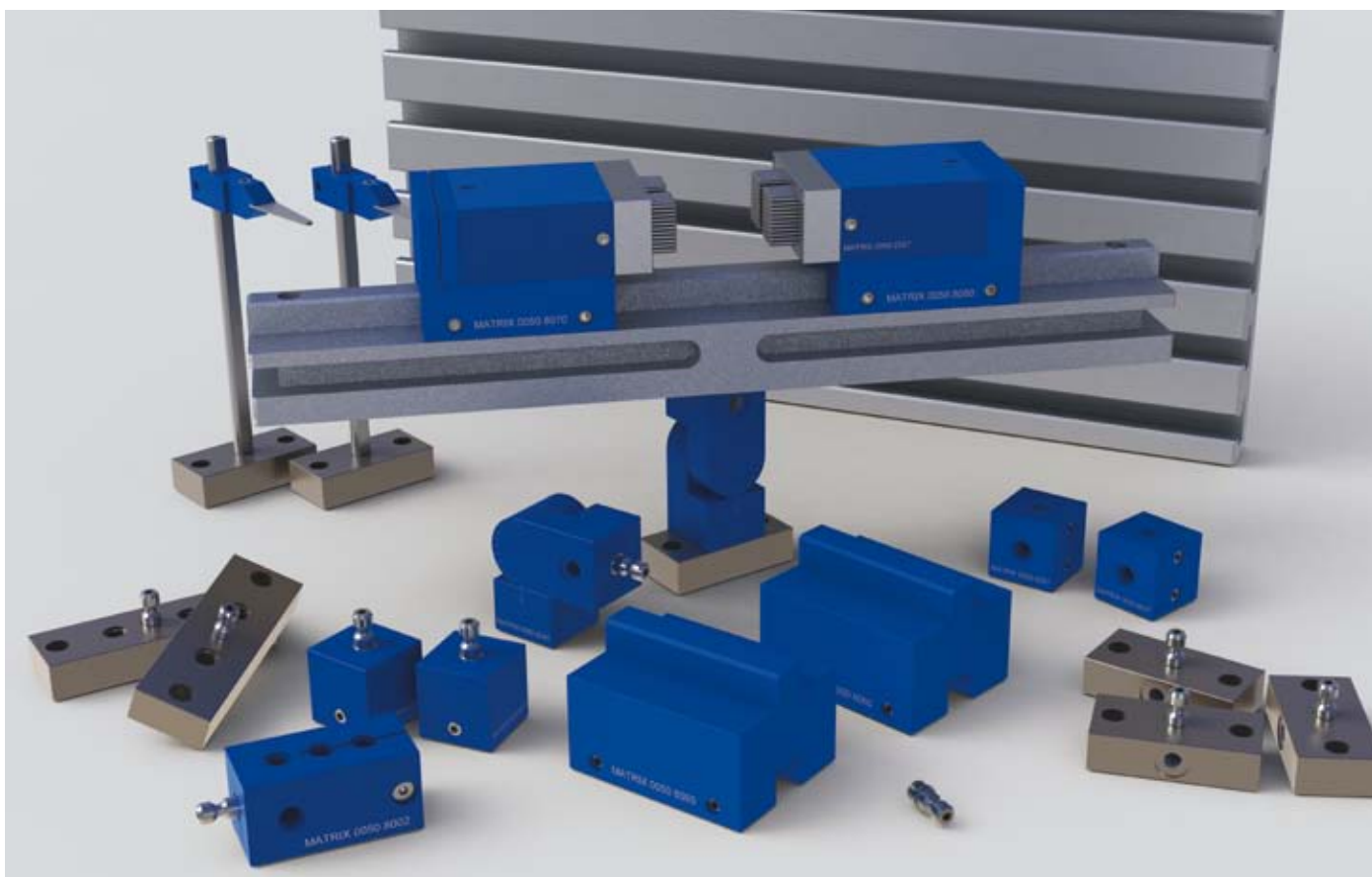

Total (without optional equipment): 30 Components



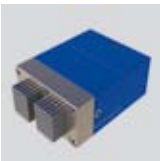













The **X-GRIP MINI M** is a form-closure and fast **holding system** with two pin-jaws for filigree and lightweight parts with unsurpassed resolution (1 mm pin diameter).

The modular system consisting of the following individual components:

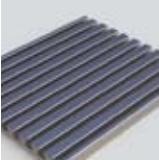
Modules	Article no.	Quantity	Designation	Dimensions and information
	0050.2527	2 x	X-GRIP MINI Module, double	Outer dimensions: 20 x 40 x 50 mm, Tightening surface: approx. 14 x 11 mm 2x, Number of pins: 252, Pin diameter: 1 mm, Stroke: 7,5 mm, Weight: approx. 132g, Clamping screw: M4 hexagon SW2, Material pins/housing: stainless steel, aluminum anodized, Adaption: connection pins: Ø 5, Installation location: any, Air connections for cleaning, Data sheet on request.

Components	Article no.	Quantity	Designation/Info	Article no.	Quantity	Designation/Info
	0050.8010	1 x	Guide rail 250 mm		0050.8070	1 x Carriage, adjustable
	0050.8080	1 x	Carriage, fixed		0050.8060	2 x Height adjustment 25 mm

Components	Article no.	Quantity	Designation/Info		Article no.	Quantity	Designation/Info
	0050.8009	6 x	Baseplate, single		0050.8008	2 x	Baseplate, double
	0050.8052	2 x	Holding rod 100 mm with scale		0050.8003	2 x	Holder, single
	0050.8002	1 x	Holder, double		0050.8050	2 x	Pressure pad
	0050.8007	2 x	Double-joint 90°		0050.8001	2 x	Intermediate module 20 mm
	0050.8013	15 x	Connection pin with hexagon 13,5 mm		0050.8040	1 x	Knuckle joint infinitely variable
	0900.2505	16 x	Fastening kit for X-Grip		0900.0200	1 x	T-slot Baseplate, 250 x 200 mm
	0900.1000	1 x	Micro screw-driver		0900.9005	1 x	MATRIX® case

Optional	Article no.	Quantity	Designation/Info		Article no.	Quantity	Designation/Info
	0050.8005	1 x	Adapter, single		0050.8006	1 x	Adapter, double

An adapter system, which is available as "optional equipment", allows you to use the X-GRIP MINI in combination with other MATRIX® products.

Total (without optional equipment): 60 Components

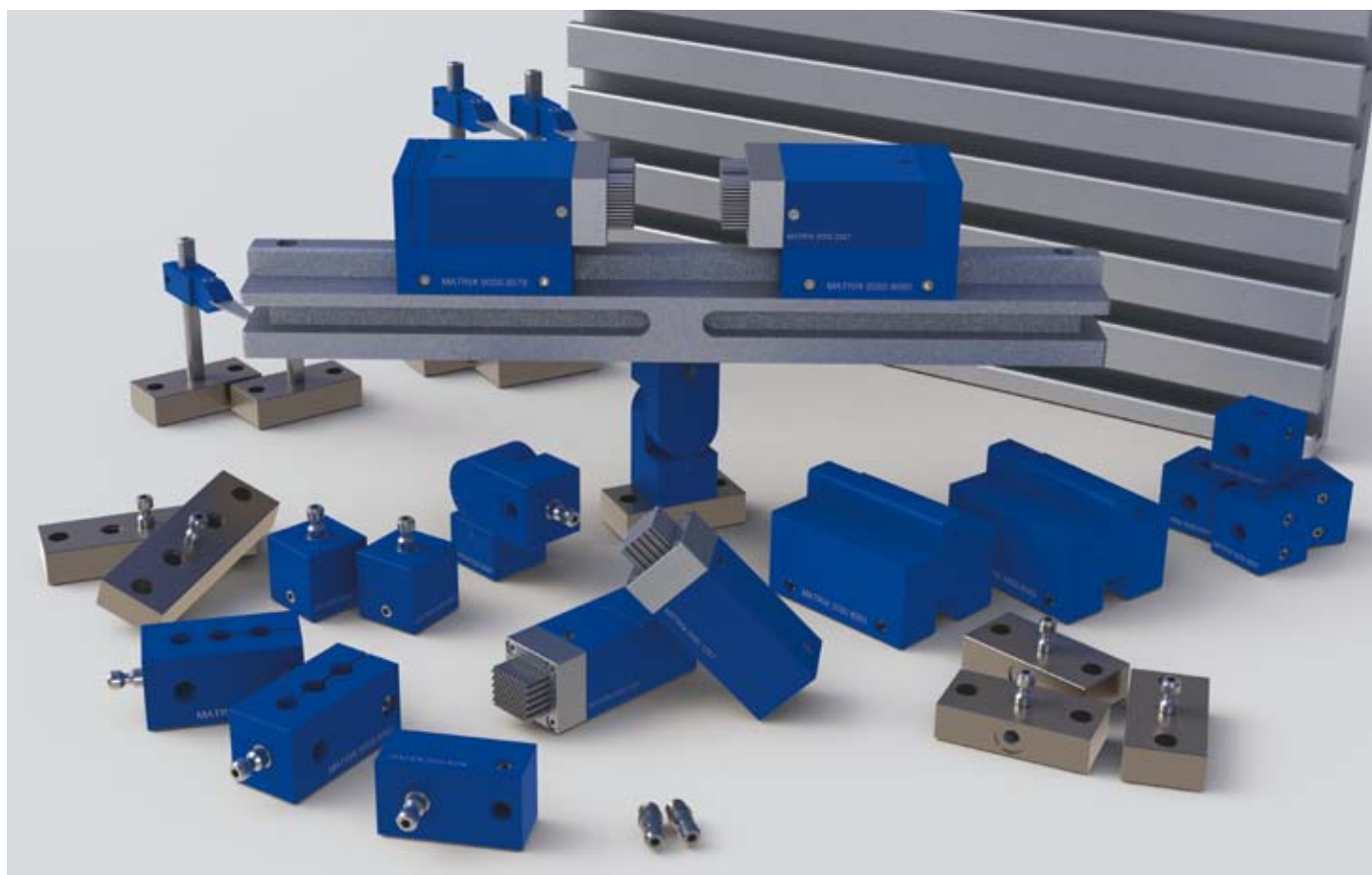



The **X-GRIP MINI L** is the most recent version of the top technology in unsurpassed resolution (1 mm pin diameter) for fast form closure with complicated contours, for **mounting** and **holding** delicate and small parts.

The modular system consisting of the following individual components:

Modules	Article no.	Quantity	Designation	Dimensions and information		
	0050.1267	2 x	X-GRIP MINI Module, single	Outer dimensions: 20 x 20 x 50 mm, Tightening surface: approx. 14 x 11 mm, Number of pins: 126, Pin diameter: 1 mm, Stroke: 7,5 mm, Weight: approx. 67g, Clamping screw: M4 hexagon SW2, Material pins/housing: stainless steel, aluminum anodized, Adaption: connection pins: Ø 5, Installation location: any, Air connections for cleaning, Data sheet on request.		
	0050.2527	2 x	X-GRIP MINI Module, double	Outer dimensions: 20 x 40 x 50 mm, Tightening surface: approx. 14 x 11 mm 2x, Number of pins: 252, Pin diameter: 1 mm, Stroke: 7,5 mm, Weight: approx. 132g, Clamping screw: M4 hexagon SW2, Material pins/housing: stainless steel, aluminum anodized, Adaption: connection pins: Ø 5, Installation location: any, Air connections for cleaning, Data sheet on request.		
Components	Article no.	Quantity	Designation/Info	Article no.	Quantity	Designation/Info
	0050.8010	1 x	Guide rail 250 mm		0050.8070	1 x Carriage, adjustable
	0050.8080	1 x	Carriage, fixed		0050.8060	2 x Height adjustment 25 mm

Components	Article no.	Quantity	Designation/Info		Article no.	Quantity	Designation/Info
	0050.8009	8 x	Baseplate, single		0050.8008	2 x	Baseplate, double
	0050.8051	2 x	Holding rod 50 mm with Skala		0050.8052	2 x	Holding rod 100 mm with scale
	0050.8003	4 x	Holder, single		0050.8002	2 x	Holder, double
	0050.8050	4 x	Pressure pad		0050.8004	1 x	Adapter plate
	0050.8007	4 x	Double-joint 90°		0050.8001	2 x	Intermediate module 20 mm
	0050.8013	20 x	Connection pin with hexagon 13,5 mm		0050.8040	2 x	Knuckle joint infinitely variable
	0900.2505	20 x	Fastening kit for X-Grip		0900.0200	1 x	T-slot Baseplate, 250 x 200 mm
	0900.1000	1 x	Micro screwdriver		0900.9005	1 x	MATRIX® case

Optional	Article no.	Quantity	Designation/Info		Article no.	Quantity	Designation/Info
	0050.8005	1 x	Adapter, single		0050.8006	1 x	Adapter, double

An adapter system, which is available as "optional equipment", allows you to use the X-GRIP MINI in combination with other MATRIX® products.

Total (without optional equipment): 84 Components

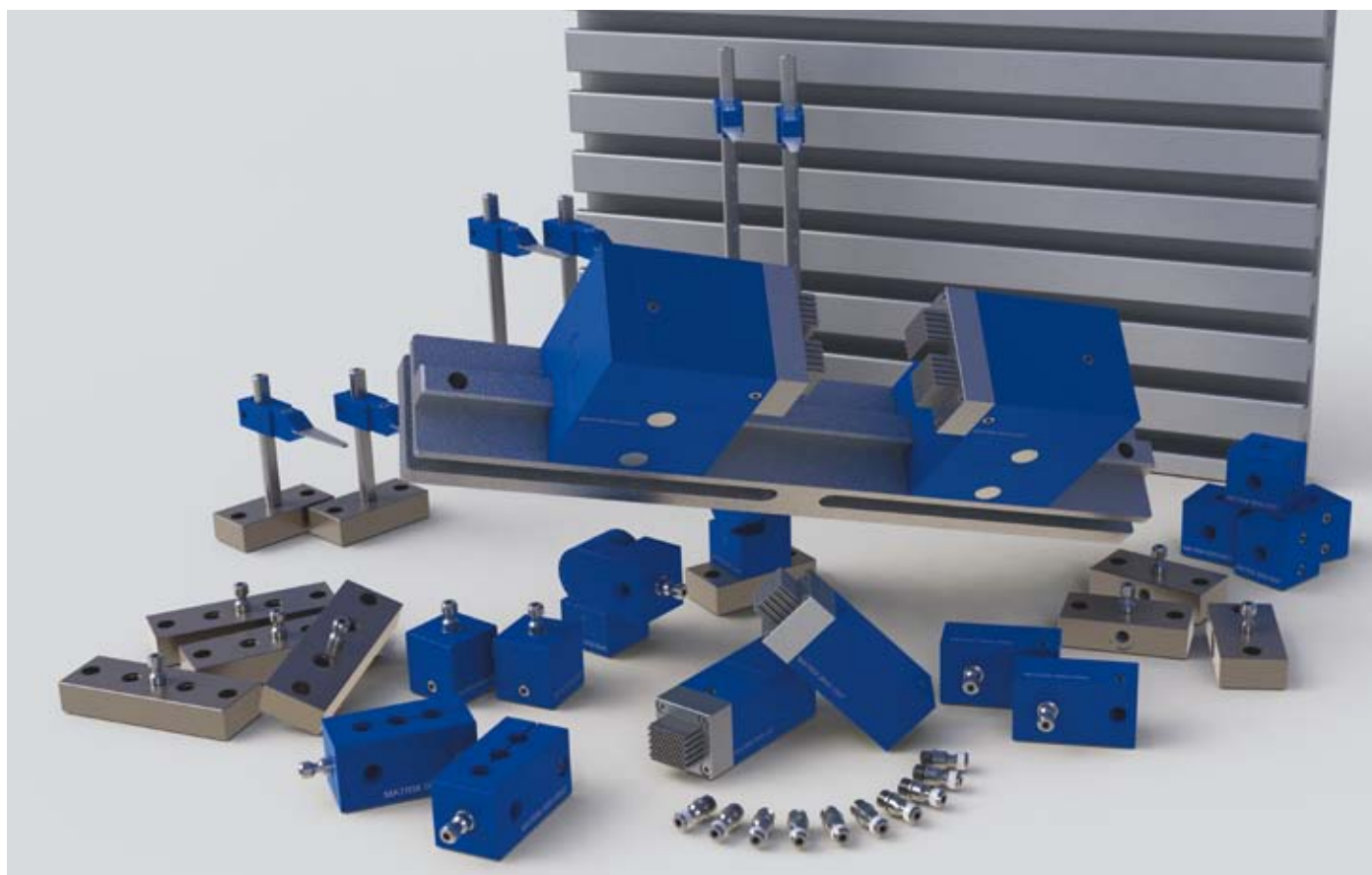



The **X-GRIP MINI XL** is essential for the professional who needs to quickly fix a wide range of small and filigree components. The **professional collection of modules** is equipped with a fast pushbutton grid carriage.

The modular system consisting of the following individual components:

Modules	Article no.	Quantity	Designation	Dimensions and information		
	0050.1267	2 x	X-GRIP MINI Module, single	Outer dimensions: 20 x 20 x 50 mm, Tightening surface: approx. 14 x 11 mm, Number of pins: 126, Pin diameter: 1 mm, Stroke: 7,5 mm, Weight: approx. 67g, Clamping screw: M4 hexagon SW2, Material pins/housing: stainless steel, aluminum anodized, Adaption: connection pins: Ø 5, Installation location: any, Air connections for cleaning, Data sheet on request.		
	0050.2527	2 x	X-GRIP MINI Module, double	Outer dimensions: 20 x 40 x 50 mm, Tightening surface: approx. 14 x 11 mm 2x, Number of pins: 252, Pin diameter: 1 mm, Stroke: 7,5 mm, Weight: approx. 132g, Clamping screw: M4 hexagon SW2, Material pins/housing: stainless steel, aluminum anodized, Adaption: connection pins: Ø 5, Installation location: any, Air connections for cleaning, Data sheet on request.		
Components	Article no.	Quantity	Designation/Info	Article no.	Quantity	Designation/Info
	0050.8010	1 x	Guide rail 250 mm		0050.8020	2 x Grid carriage with pushbutton
	0050.8030	2 x	Height adjustment for grid carriage 25 mm		0050.8040	2 x Knuckle joint infinitely variable

Components	Article no.	Quantity	Designation/Info		Article no.	Quantity	Designation/Info
	0050.8009	10 x	Baseplate, single		0050.8008	4 x	Baseplate, double
	0050.8051	2 x	Holding rod 50 mm with scale		0050.8052	2 x	Holding rod 100 mm with scale
	0050.8053	2 x	Holding rod 150 mm with scale		0050.8003	6 x	Holder, single
	0050.8002	2 x	Holder double		0050.8004	2 x	Adapter plate
	0050.8050	6 x	Pressure pad		0050.8001	2 x	Intermediate module 20 mm
	0050.8007	4 x	Double-joint 90°		0050.8013	33 x	Connection pin with hexagon 13,5 mm
	0900.2505	30 x	Fastening kit for X-Grip		0900.0200	1 x	T-slot Baseplate, 250 x 200 mm
	0900.1000	1 x	Micro screwdriver		0900.9005	1 x	MATRIX® case

Optional	Article no.	Quantity	Designation/Info		Article no.	Quantity	Designation/Info
	0050.8005	1 x	Adapter, single		0050.8006	1 x	Adapter, double

An adapter system, which is available as "optional equipment", allows you to use the X-GRIP MINI in combination with other MATRIX® products.

Total (without optional equipment): 118 Components

Overview:



S M L XL

Order number of individual kit:

0050.2510 0050.2520 0050.2530 0050.2540

Components	Article no.	Designation/Info	Quantity per kit:			
	0050.1267	X-GRIP MINI Module, single	1		2	2
	0050.2527	X-GRIP MINI Module, double	1	2	2	2
	0050.8010	Guide rail 250 mm		1	1	1
	0050.8080	Carriage, fixed		1	1	
	0050.8020	Grid carriage with pushbutton				2
	0050.8070	Carriage, adjustable		1	1	
	0050.8060	Height adjustment, fixed 25 mm		2	2	
	0050.8030	Height adjustment with pushbutton for grid carriage 25 mm				2
	0050.8009	Baseplate, single	3	6	8	10
	0050.8008	Baseplate, double	1	2	2	4
	0050.8051	Holding rod 50 mm with scale			2	2
	0050.8052	Holding rod 100 mm with scale	2	2	2	2

S M L XL

Components	Article no.	Designation/Info	Quantity per kit:			
	0050.8053	Holding rod 150 mm with scale				2
	0050.8050	Pressure pad	2	2	4	6
	0050.8003	Holder, single	2	2	4	6
	0050.8002	Holder, double		1	2	2
	0050.8040	Knuckle joint infinitely variable		1	2	2
	0050.8007	Double-joint 90°	2	2	4	4
	0050.8004	Adapter plate			1	2
	0050.8001	Intermediate module 20 mm		2	2	2
	0050.8013	Connection pin with hexagon 13,5 mm	6	15	20	33
	0900.0200	T-slot Baseplate, 250 x 200 mm	1	1	1	1
	0900.2505	Fastening kit for X-Grip	8	16	20	30
	0900.1000	Micro screwdriver	1	1	1	1
Quantity of all components:			30	60	84	118

MATRIX® GmbH Stuttgart

Clamping Systems & Production Automation

Felix-Wankel-Straße 6
73760 Ostfildern | Germany

Telephone: +49 (0) 711 22 93 28 - 0

Telefax: +49 (0) 711 22 93 28 - 22

E-mail: info@matrix-innovations.com

Visit us on Internet at:

www.matrix-innovations.com