



Produktübersicht / Range of Products

MATRIX Standard Sets

Auflage- und Haltesysteme / Support- and Holding-Systems



X-Support XL Set

Bestell-Nummer/ Order-Number: 0050.3168

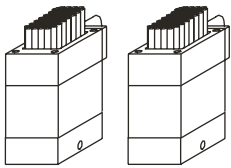

2 St/pcs. [0050.6724](#)

X-Support XL Modul
 Grundfläche/base size: 50 x 100 mm
 Stöbel-Feld/pin field: 79 x 30 mm
 Anzahl der Stöbel/number of pins: 67 Stück/pieces
 Stöbel-Durchmesser/pin diameter: 6 mm
 Stöbel-Hub/pin stroke: 21 mm
 Anschlusselement Gehäuse/
 Connection module housing

2 St/pcs. [0050.6726](#)

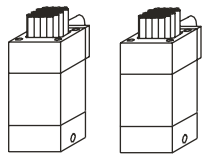

2 St/pcs. [0050.3124](#)

X-Support XL Modul
 Grundfläche/base size: 50 x 50 mm
 Stöbel-Feld/pin field: 37 x 30 mm
 Anzahl der Stöbel/number of pins: 31 Stück/pieces
 Stöbel-Durchmesser/pin diameter: 6 mm
 Stöbel-Hub/pin stroke: 21 mm
 Anschlusselement Gehäuse/
 Connection module housing

2 St/pcs. [0050.3126](#)

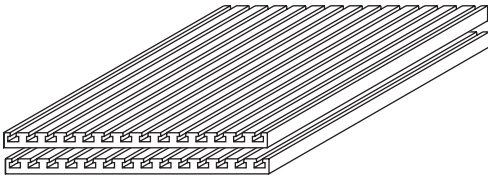

2 St/pcs. [0900.0500](#)

T-Nuten Profilplatte/
 T-slotted profil plate
 Grundfläche/base size: 375 x 500 mm
 Nutbreite/slot width: 8 mm

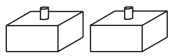

[0050.3127](#)
 Anschlusselement
 Connection module
 25 x 50 x 50 mm

2 Stück/pieces

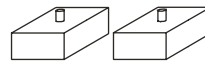

[0050.6727](#)
 Anschlusselement
 Connection module
 25 x 50 x 100 mm

2 Stück/pieces



[0050.3128](#)
 Grundplatte
 Base plate
 10 x 50 x 100 mm

2 Stück/pieces

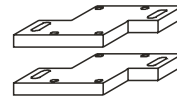

[0050.6728](#)
 Grundplatte
 Base plate
 10 x 100 x 100 mm

2 Stück/pieces

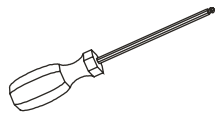

[0900.0000](#)
 Schraubendreher
 Screwdriver



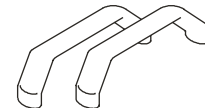



1 Stück/piece

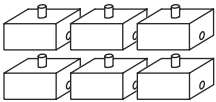
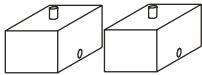
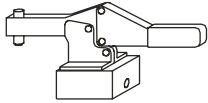
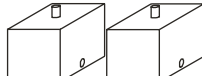
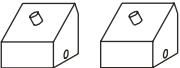
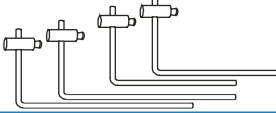
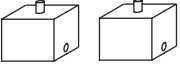

[0900.3620](#)
 Bügelgriffe
 Handles

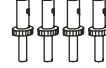
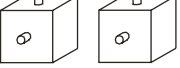
2 Stück/pieces

X-Support XL Set

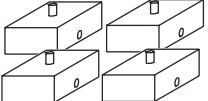
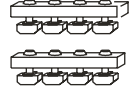
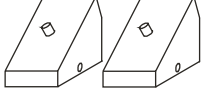
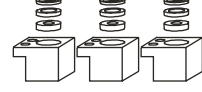
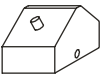
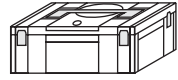
	0050.3125 Zwischenelement Intermediate module 25 x 50 x 50 mm	6 Stück/pieces		0050.6740 Zwischenelement Intermediate module 40 x 50 x 100 mm	2 Stück/pieces
	0050.3129 Horizontalspanner Horizontal-handle	1 Stück/piece		0050.6750 Zwischenelement Intermediate module 50 x 50 x 100 mm	2 Stück/pieces
	0050.3130 Winkelement 30° Angle 30° 50 x 50 mm	2 Stück/pieces		0050.3115 + 0050.3116 Niederhalter 120+200 mm Retaining arm 120+200 mm	je/per 2 Stück/pieces
	0050.3140 Zwischenelement Intermediate module 40 x 50 x 50 mm	2 Stück/pieces		0050.3117 + 0050.3119 Anschlag und Einstellring Stop and adjusting ring	1 Stück/piece
	0050.3141 Zwischenel. f. Niederhalter Module for retaining arm 40 x 50 x 50 mm	1 Stück/piece		0050.3118 Verlängerungs-Set Extension-Set	4 Stück/pieces
	0050.3150 Gelenkelement Intermediate module 50 x 50 x 50 mm	2 Stück/pieces		0900.4001 + 0900.4002 Kegelaufnahme/Cone Prismenaufnahme/ V-block	1 Stück/piece
	0050.3151 Element für Einsätze Module for inserts	1 Stück/piece		0900.2501 Befestigungs-Satz Mounting kit 8 St/8 pcs.	1 Set
	0050.6725 Zwischenelement Intermediate module 25 x 50 x 100 mm	4 Stück/pieces		0900.2500 Verbindungselement Connection module 2 St/2 pcs.	1 Set
	0050.6730 Winkelement 30° Angle 30° 50 x 100 mm	2 Stück/pieces		0900.0501 Spannpratzen Mounting kit 3 St/3 pcs.	1 Set
	0050.6732 Doppelwinkel 30° Double angle 30° 50 x 100 mm	1 Stück/piece		0900.9000 Koffer mit Einlagen u.Trolley Case with Inlays and Trolley	2 Stück/pieces

X-Support XL Light Set

Bestell-Nummer/Order-Number: 0050.3169

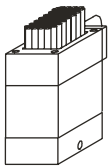

1 St/pc. [0050.6724](#)

X-Support XL Modul
 Grundfläche/base size: 50 x 100 mm
 Stöbel-Feld/pin field: 79 x 30 mm
 Anzahl der Stöbel/number of pins: 67 Stück/pieces
 Stöbel-Durchmesser/pin diameter: 6 mm
 Stöbel-Hub/pin stroke: 21 mm
 Anschlusselement Gehäuse/
 Connection module housing

1 St/pc. [0050.6726](#)

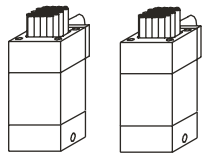

2 St/pcs. [0050.3124](#)

X-Support XL Modul
 Grundfläche/base size: 50 x 50 mm
 Stöbel-Feld/pin field: 37 x 30 mm
 Anzahl der Stöbel/number of pins: 31 Stück/pieces
 Stöbel-Durchmesser/pin diameter: 6 mm
 Stöbel-Hub/pin stroke: 21 mm
 Anschlusselement Gehäuse/
 Connection module housing

2 St/pcs. [0050.3126](#)

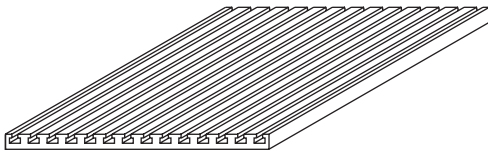

1 St/pc. [0900.0500](#)

T-Nuten Profilplatte/
 T-slotted profil plate
 Grundfläche/base size: 375 x 500 mm
 Nutbreite/slot width: 8 mm

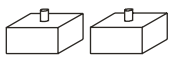

[0050.3127](#)
 Anschlusselement
 Connection module
 25 x 50 x 50 mm

2 Stück/pieces

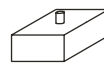

[0050.6727](#)
 Anschlusselement
 Connection module
 25 x 50 x 100 mm

1 Stück/piece



[0050.3128](#)
 Grundplatte
 Base plate
 10 x 50 x 100 mm

2 Stück/pieces

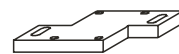

[0050.6728](#)
 Grundplatte
 Base plate
 10 x 100 x 100 mm

1 Stück/piece

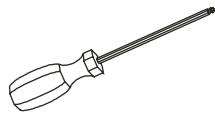

[0900.0000](#)
 Schraubendreher
 Screwdriver



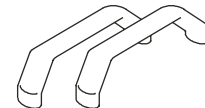



1 Stück/piece

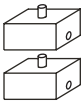
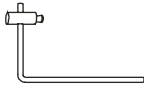

[0900.3620](#)
 Bügelgriffe
 Handles

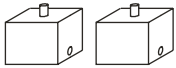
2 Stück/pieces

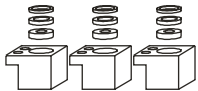
X-Support XL Light Set

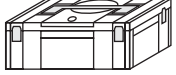
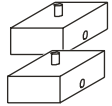
	0050.3125 Zwischenelement Intermediate module 25 x 50 x 50 mm	2 Stück/pieces		0050.3115 Niederhalter 120 mm Retaining arm 120 mm	1 Stück/piece
	0050.3130 Winkelement 30° Angle 30° 50 x 50 mm	1 Stück/piece		0050.3116 Niederhalter 200 mm Retaining arm 200 mm	2 Stück/pieces
	0050.3140 Zwischenelement Intermediate module 40 x 50 x 50 mm	2 Stück/pieces		0900.2501 Befestigungs-Satz Mounting kit 8 St/8 pcs.	1 Set
	0050.3141 Zwischenel. f. Niederhalter Module for retaining arm 40 x 50 x 50 mm	1 Stück/piece		0900.0501 Spannpratzen Mounting kit 3 St/3 pcs.	1 Set
	0050.3150 Gelenkelement Intermediate module 50 x 50 x 50 mm	1 Stück/piece		0900.9000 Koffer mit Einlagen Case with Inlays	1 Stück/piece
	0050.6725 Zwischenelement Intermediate module 25 x 50 x 100 mm	2 Stück/pieces			

X-Support SXS Set

Bestell-Nummer/Order-Number: 0050.1210

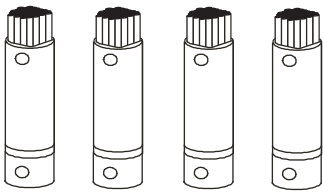

4 St/pc. **0050.1237**

X-Support SXS Modul

Grundfläche/base size:

Ø 26 mm

Anzahl der Stöbel/number of pins:

37 Stück/pieces

Stöbel-Durchmesser/pin diameter:

2,5 mm

Stöbel-Hub/pin stroke:

12 mm

4 St/pc. **0050.1226**

Anschlusselement Gehäuse/

Connection module housing

Ø 26 mm

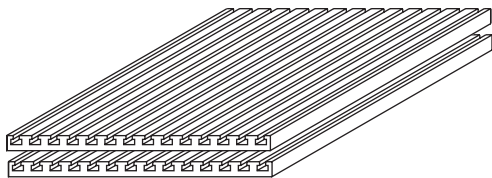

2 St/pcs. **0900.0500**

T-Nuten Profilplatte/

T-slotted profil plate

Grundfläche/base size:

375 x 500 mm

Nutbreite/slot width:

8 mm

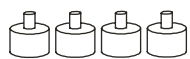

0050.1227

Anschlusselement
Connection module
25 x Ø 26 mm

4 Stück/pieces

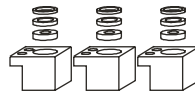

0900.0501

Spannpratzen
Mounting kit
3 St/3 pcs.

1 Set

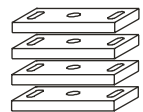

0050.1228

Grundplatte
Base plate
65 x 28 x 10 mm

4 Stück/pieces

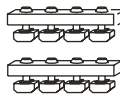

0900.2500

Verbindungselement
Connection module
2 St/2 pcs.

1 Set

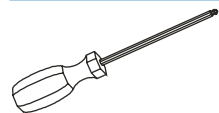

0900.0000

Schraubendreher
Screwdriver

1 Stück/piece

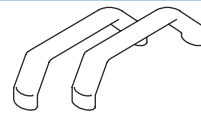







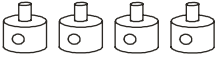
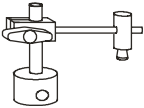
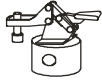
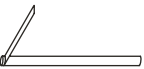
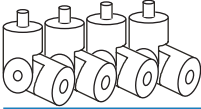
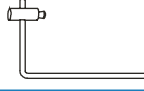
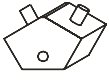
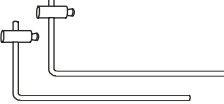
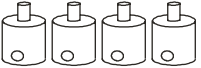

0900.3620

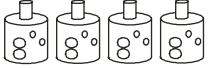
Bügelgriffe
Handles

2 Stück/pieces

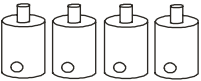
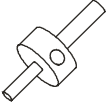
X-Support SXS Set

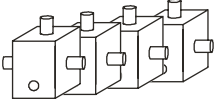
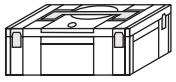
	0050.1225 Zwischenelement Intermediate module 25 x Ø 26 mm	4 Stück/pieces		0050.1216 Niederhalter extern Retaining arm extern Ø 26 mm	1 Stück/piece
	0050.1229 Horizontalspanner Horizontal-handle	1 Stück/piece		0050.1425 Niederhalter Retaining arm	1 Stück/piece
	0050.1230 Winkelstück stufenlos Ø 26 mm	4 Stück/pieces		0050.3115 Niederhalter 120 mm Retaining arm 120 mm	1 Stück/piece
	0050.1232 Doppelwinkel 30° Double angle 30°	1 Stück/piece		0050.3116 Niederhalter 200 mm Retaining arm 200 mm	2 Stück/pieces
	0050.1240 Zwischenelement Intermediate module 40 x Ø 26 mm	4 Stück/pieces		0050.3117 Anschlag Stop	1 Stück/piece
	0050.1241 Element f. Niederhalter Module for Retaining arm 40 x Ø 26 mm	4 Stück/pieces		0900.4001 Kegeleinsatz Cone insert 90°	1 Stück/piece
	0050.1242 Höhenverstellbares Modul Height adjustable modul Ø 26 mm	1 Stück/piece		0900.4002 Prismeneinsatz 90° V-Block	1 Stück/piece
	0050.1250 Zwischenelement Intermediate module 50 x Ø 26 mm	4 Stück/pieces		0900.4003 Einzelstößel-Einsatz Single pin insert	1 Stück/piece
	0050.1251 Element für Einsätze Module for inserts 50 x Ø 26 mm	1 Stück/piece		0900.2501 Befestigungs-Satz Mounting Kit 8 St/8 pcs.	1 Set
	0050.1252 Gelenkstück 90° Double angle 90° 26 x 26 x 35 mm	4 Stück/pieces		0900.9000 Koffer mit Einlagen Case with Inlays	1 Stück/piece

X-Grid Set

Bestell-Nummer/Order-Number: 0900.0510

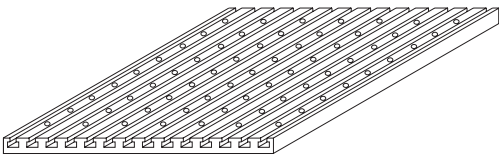

1 St/pc. 0900.0505

T-Nuten Rasterprofilplatte/
T-slotted grid plate
Grundfläche/base size: 375 x 500 mm
Nutbreite/slot width: 8 mm
Raster/grid: 50 x 50 mm
Gewindeinsatz/threaded insert: M6
Positionsangabe laserbeschriftet/
position laser signed

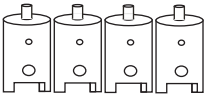

0050.1244
Anschlusselement
Connection module
40 x Ø 26 mm
4 Stück/pieces



0050.1245
Niederzugzapfen M6
Connection pin
4 Stück/pieces

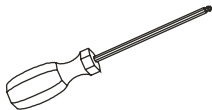

0900.0000
Schraubendreher
Screwdriver
1 Stück/piece

X-Support XS Set

Bestell-Nummer/Order Number: 0050.1424

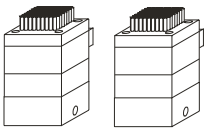

2 St/pcs. 0050.1423

X-Support XS Modul

Grundfläche/base size: 50 x 50 mm
 Stößel-Feld/pin field: 39 x 29 mm
 Anzahl der Stößel/number of pins: 142 Stück/pieces
 Stößel-Durchmesser/pin diameter: 2,5 mm
 Stößel-Hub/pin stroke: 12 mm
 Anschlusselement Gehäuse/
 Connection module housing

2 St/pcs. 0050.3126

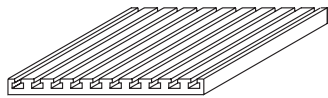

1 St/pcs. 0900.0200

T-Nuten Profilplatte/
 T-slotted profil plate
 Grundfläche/base size:
 Nutbreite/slot width:

250 x 200 mm
 8 mm

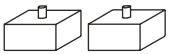

0050.3127
 Anschlusselement
 Connection modul
 25 x 50 x 50 mm

2 Stück/pieces

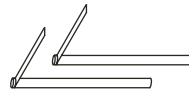

0050.1425
 Niederhalter
 Retaining arm

2 Stück/pieces



0050.3128
 Grundplatte
 Base plate
 10 x 50 x 100 mm

2 Stück/pieces



0900.2501
 Befestigungs-Satz
 Mounting kit
 8 St/8 pcs.

1 Set

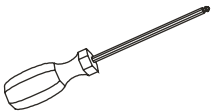

0900.0000
 Schraubendreher
 Screwdriver

1 Stück/piece

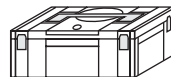

0900.9000
 Koffer mit Einlagen
 Case with Inlays

1 Stück/piece

X-Grip XL Set

Bestell-Nummer/Order-Number: 0050.6225

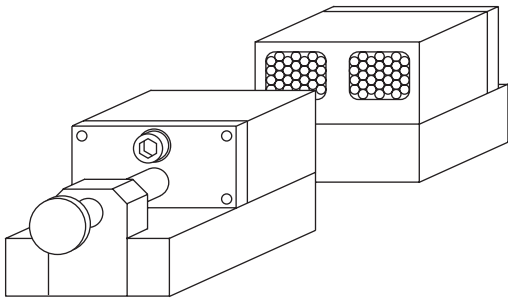

X-Grip XL Modul
 Grundfläche fester Backen/
 base size fixed jaw: 100 x 100 mm
 Grundfläche beweglicher Backen/
 base size movable jaw: 100 x 100 mm
 Stößel-Feld/pin field: 79 x 30 mm
 Anzahl der Stößel/number of pins: 62 Stück/pieces*
 Stößel-Durchmesser/pin diameter: 6 mm
 Stößel-Hub/pin stroke: 21 mm

*pro Backen/per jaw

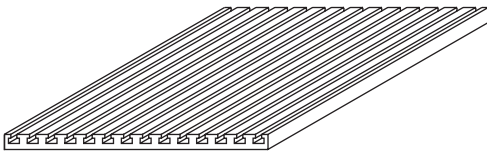

1 St/pc. 0900.0500

T-Nuten Profilplatte/
 T-slotted profil plate
 Grundfläche/base size: 375 x 500 mm
 Nutbreite/slot width: 8 mm

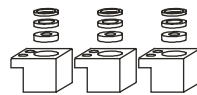

0900.0501
 Spannpratzen
 Mounting kit
 3 St/3 pcs. 1 Set

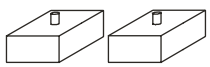

0050.6727
 Anschlusselement
 Connection module
 25 x 50 x 100 mm
 2 Stück/pieces



0900.2501
 Befestigungs-Satz
 Mounting kit
 8 St/8 pcs. 1 Set

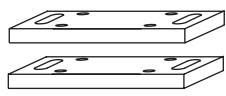

0800.7150
 Grundplatte
 Base plate
 10 x 50 x 150 mm
 2 Stück/pieces

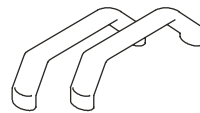

0900.3620
 Bügelgriffe
 Handles
 2 Stück/pieces

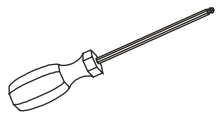

0900.0000
 Schraubendreher
 Screwdriver
 1 Stück/piece

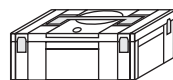

0900.9000
 Koffer mit Einlagen
 Case with Inlays
 1 Stück/piece

X-Grip XS Light Set

Bestell-Nummer/Order-Number: 0050.5813

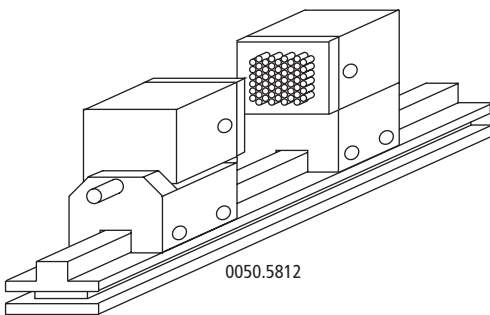

1 St/pc. **0050.5812**

X-Grip XS Modul
 Grundfläche/base: 38 x 250 mm
 Anzahl der Stößel/number of pins: 58 Stück/pieces*
 Stößel-Durchmesser/pin diameter: 2,5 mm
 Stößel-Hub/pin stroke: 12 mm

*pro Backen/per jaw

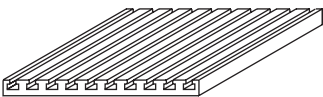

1 St/pc. **0900.0200**

T-Nuten Profilplatte/
 T-slotted profil plate
 Grundfläche/base size: 250 x 200 mm
 Nutbreite/slot width: 8 mm



0050.5825
 Zwischenelement
 Intermediate module
 25 x 50 x 50 mm
 (1 Stück/piece)

1 Set

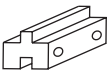

25 x 50 x 70 mm
 (1 Stück/piece)

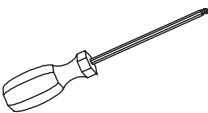

0900.0000
 Schraubendreher
 Screwdriver

1 Stück/piece



0900.2501
 Befestigungs-Satz
 Mounting Kit
 8 St/8 pcs. 1 Set

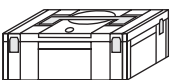

0900.9000
 Koffer mit Einlagen
 Case with Inlays

1 Stück/piece



0900.0502
 Spannpratzen
 Mounting kit 2 Stück/pieces

X-Grip XS Set

Bestell-Nummer/Order-Number: 0050.5815

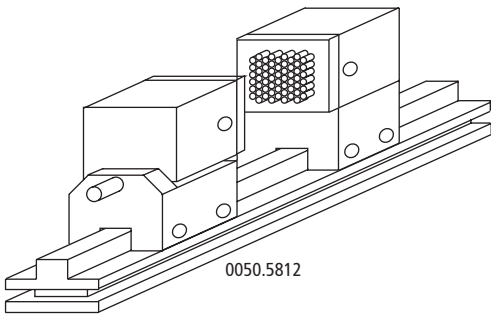

1 St/pc. **0050.5812**

X-Grip XS Modul

Grundfläche/base:

38 x 250 mm

Anzahl der Stößel/number of pins:

58 Stück/pieces*

Stößel-Durchmesser/pin diameter:

2,5 mm

Stößel-Hub/pin stroke:

12 mm

*pro Backen/per jaw

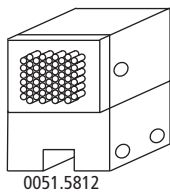

1 St/pc. **0051.5812**

Fester Backen X-Grip XS/

Fixed jaw X-Grip XS

Anzahl der Stößel/number of pins:

58 Stück/pieces

Stößel-Durchmesser/pin diameter:

2,5 mm

Stößel-Hub/pin stroke:

12 mm

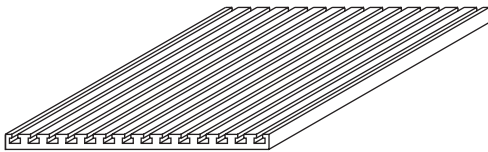

1 St/pc. **0900.0500**

T-Nuten Profilplatte/

T-slotted profil plate

Grundfläche/base size:

375 x 500 mm

Nutbreite/slot width:

8 mm

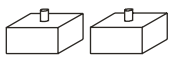

0050.3127

Anschlussselement
Connection module
25 x 50 x 50 mm

2 Stück/pieces

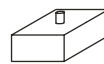

0050.6727

Anschlussselement
Connection module
25 x 50 x 100 mm

1 Stück/piece



0050.3128

Grundplatte
Base plate
10 x 50 x 100 mm

2 Stück/pieces

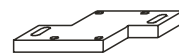

0050.6728

Grundplatte
Base plate
10 x 100 x 100 mm

1 Stück/piece

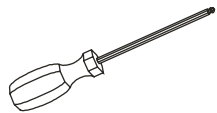

0900.0000

Schraubendreher
Screwdriver

1 Stück/piece

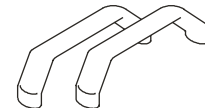







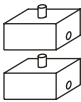
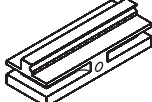
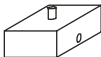

0900.3620

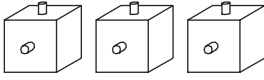
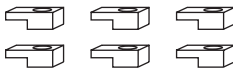
Bügelgriffe
Handles

2 Stück/pieces

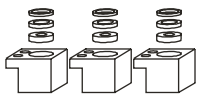
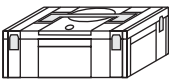
X-Grip XS Set

	0050.3125 Zwischenelement Intermediate module 25 x 50 x 50 mm	2 Stück/pieces		0050.5867 Führungsschiene bewegl. Backen/straight guide bar for moveble jaw 100 mm	1 Stück/piece
	0050.6725 Zwischenelement Intermediate module 25 x 50 x 100 mm	1 Stück/piece		0050.5831 Führungsschiene fester Backen/straight guide bar for fixed jaw 50 mm	2 Stück/pieces
	0050.3150 Gelenkelement Intermediate module 50 x 50 x 50 mm	3 Stück/pieces		0900.0506 Spannpratzen Mounting kit 6 St/6 pcs.	1 Set
	0050.5825 Zwischenelement Intermediate module 25 x 50 x 50 mm (1 Stück/pieces)	1 Set		0051.5825 Zwischenelement Intermediate module 25 x 50 x 50 mm	1 Stück/piece
	25 x 50 x 70 mm (1 Stück/piece)				
	0050.1230 Winkelstück stufenlos Ø 26 mm	1 Stück/piece		0900.0501 Spannpratzen Mounting kit 3 St/3 pcs.	1 Set
	0900.9000 Koffer mit Einlagen Case with Inlays	1 Stück/piece		0900.2501 Befestigungs-Satz Mounting Kit 8 St/ 8 pcs.	1 Set

X-Support Profil Set

Bestell-Nummer/Order-Number: 0800.2550

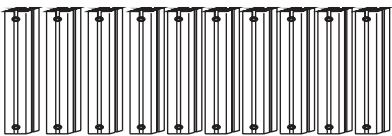

0800.0250
 Profile 50 x 50 x 250 mm
 10 Stück/pieces

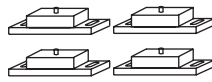

0800.6727 + 0800.7150
 Platte mit Anschluelement 4 Stck/pieces
 base plate and connection

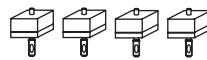

0800.3128 + 0800.3127
 Platte mit Anschluelement 4 Stck/pieces
 base plate and connection

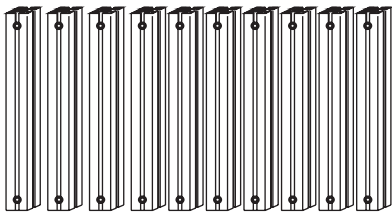

0800.0400
 Profile 50 x 50 x 400 mm
 10 Stck/pieces

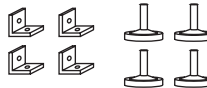

0800.6702 + 0800.3526
 Gelenkfu incl. Winkel 4 Stck/pieces
 Adapter with knuckle feet



0800.3566
 Abdeck-Kappe 20 Stck/pieces
 Cover 50 x 50 mm

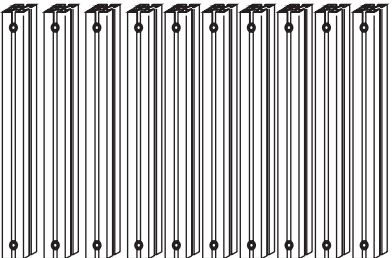

0800.0500
 Profile 50 x 50 x 500 mm
 10 Stck/pieces



0800.3701
 Gelenk 4 Stck/pieces
 Lockable joint

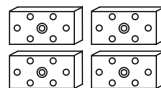

0800.3714
 Sockelplatte Gelenk 4 Stck/pieces
 Base plate for joint

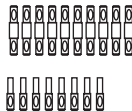

0800.3510 + 0800.3519
 Verlngerung + Verbinder 10 Stck/pieces
 Extension + Connectors

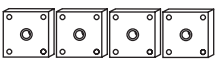

0800.3646
 Sockelplatte Profil 4 Stck/pieces
 Base plate profile



0800.3517
 Rundkopfverbinder 20 Stck/pieces
 Roundhead Connector

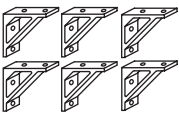

0800.3597
 Winkel gro 6 Stck/pieces
 Large angle 100 x 100 x 30



0800.3501
 Gewindeverbinder 10 Stck/pieces
 Profile Connectors



0800.3594
 Winkel klein 10 Stck/pieces
 Small Angle 48 x 48 x 30

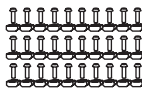

0900.2501
 Befestigung 30 Stck/pieces
 Mounting kit

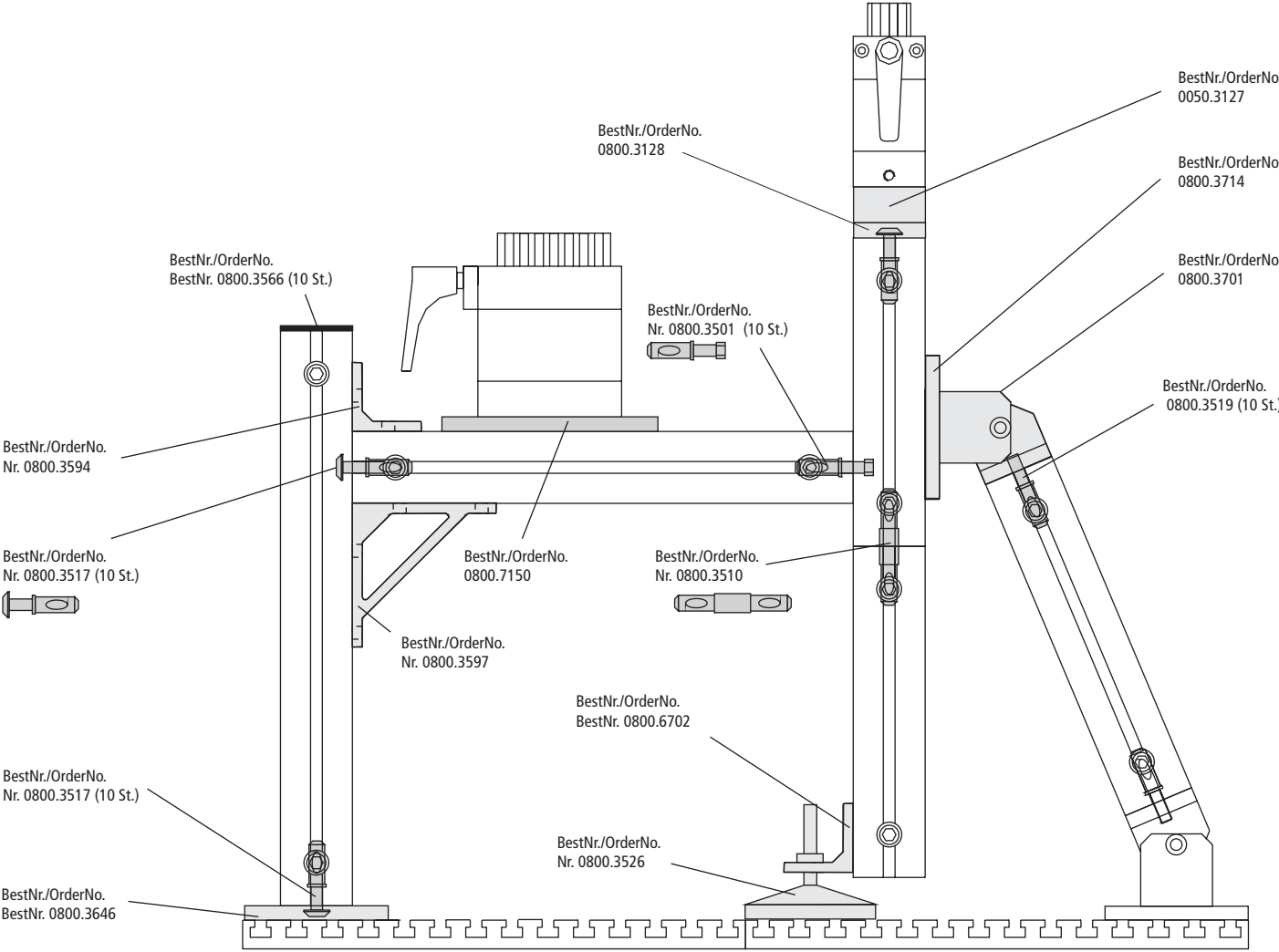

X-Shift Set

Bestell-Nummer/Order-Number: 0400.1001

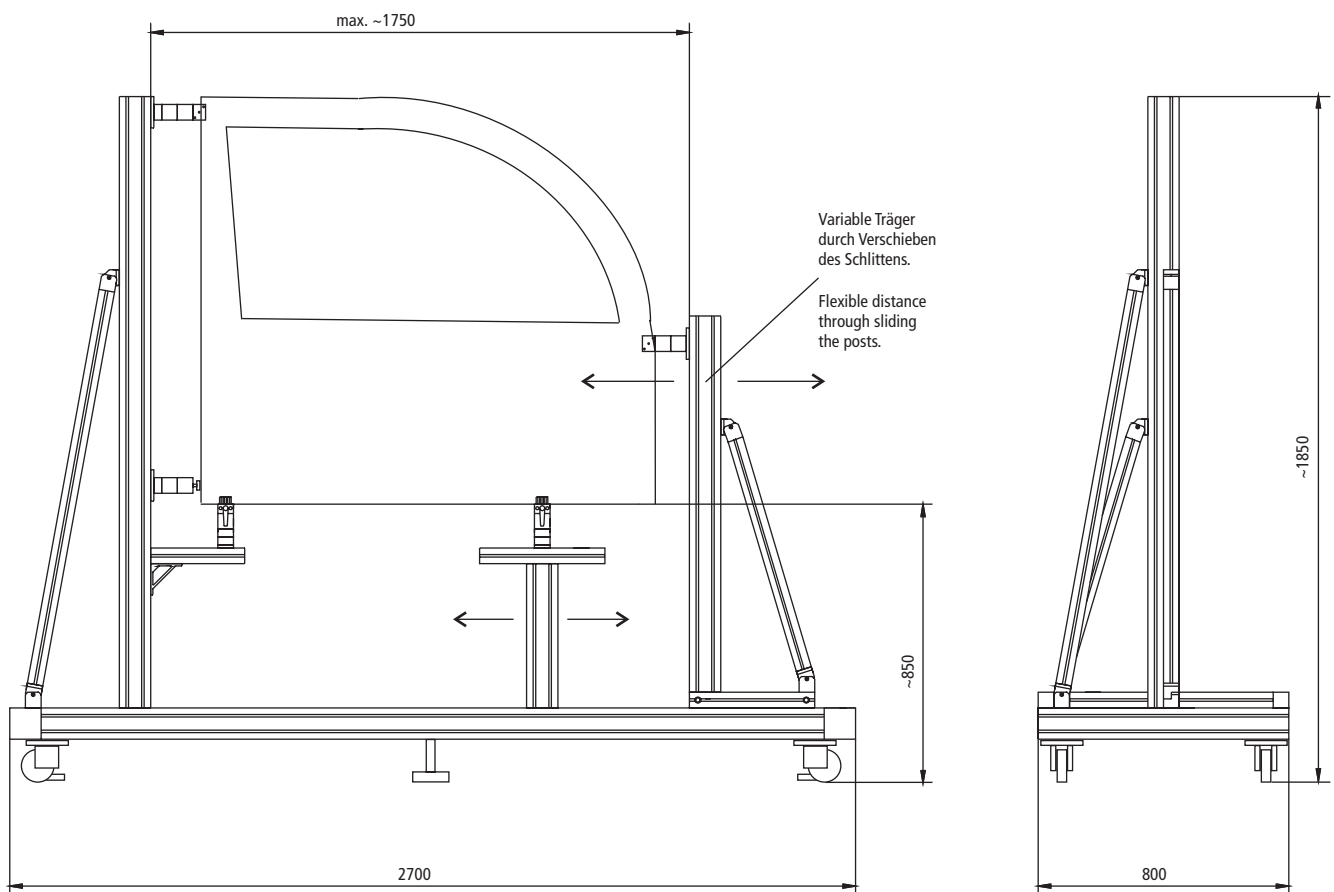

Flexible Messvorrichtung für Karosserieteile aus Aluminium Profilen.

- Schnittstellen zu Werkstücken durch X-Supports.
- Transport der Vorrichtung durch Heberollen (opt.)

Flexible fixture for measurement of body panel components.

- Connection to the work pieces with X-Supports.
- Levelling casters with adjustable mount (opt.)

X-Table

Bestell-Nummer/ Order-Number 0400.1200
Bestell-Nummer/ Order-Number 0400.1500

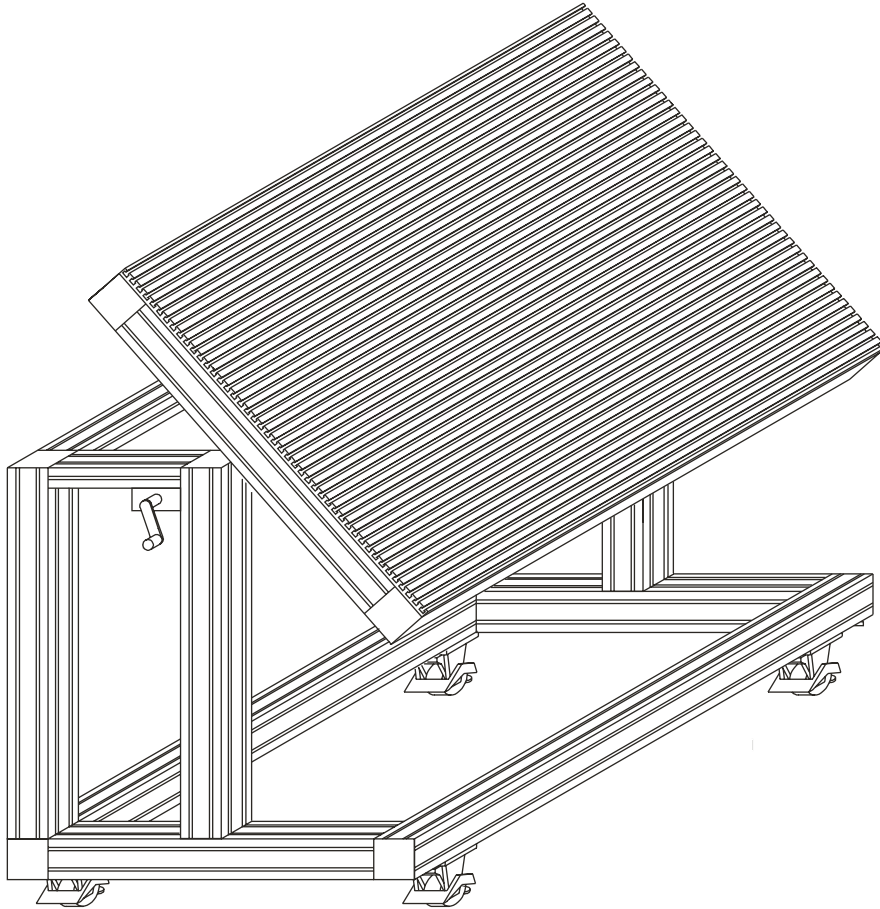

0400.1200

Arbeitsfläche/desktop: 1200 x 750 mm
Tischhöhe/height: 910 mm

Mittels Handkurbel bis zu 90° stufenlos verstellbar.
Die Tischplatte ist mit T-Nuten Profilplatten ausgerüstet.
Mobil durch Stellfüße mit integrierter Laufrolle.

0400.1500

Arbeitsfläche/desktop: 1500 x 1125 mm
Tischhöhe/height: 910 mm

Stepless tilting though 90° by means of a hand crank
Tabletop with T-slot plate
Movable with no effort because of lifting rollers

X-Support

Ergänzung - Zubehör/ Accessories

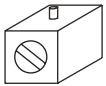

0900.9210
Magnetfuß/Magnetic base
Haltekraft/Holding force ~ 700N
55 x 50 x 75 mm



0700.5001
Adapter/Adapter Ø 12 mm
Für Lochraster Vorrichtungen
For fixuring systems with grid



0700.5002
Adapter/Adapter Ø 20 mm
Für Lochraster Vorrichtungen
For fixuring systems with grid



Notizen/ Notes





MATRIX GmbH Stuttgart

Felix-Wankel-Straße 6
73760 Ostfildern-Nellingen
Germany

Phone: +49 (0) 711 22 93 28-0
Fax +49 (0) 711 22 93 28-22

info@matrix-innovations.com
www.matrix-innovations.com



09/2008